

VLASTI

Art.-Nr.

394 131
394 136

	935
	884
	600
	mm

1/6

v0

12-2024

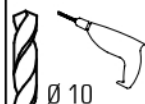
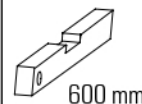
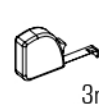
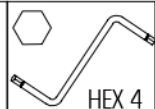
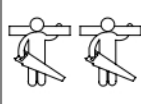



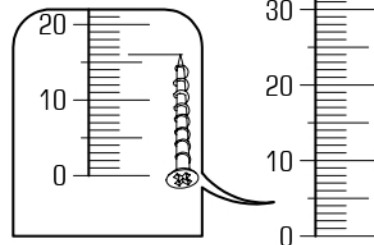
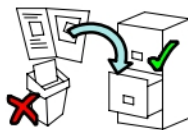
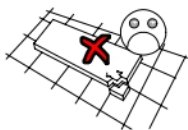
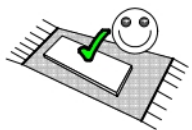
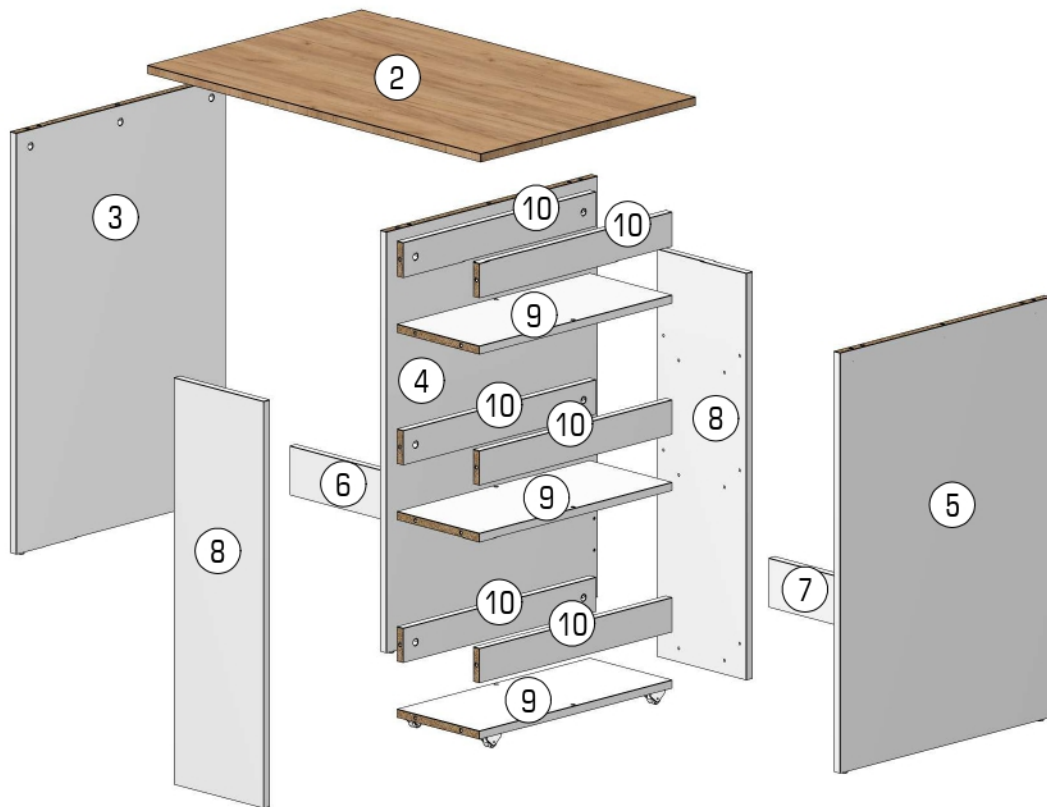
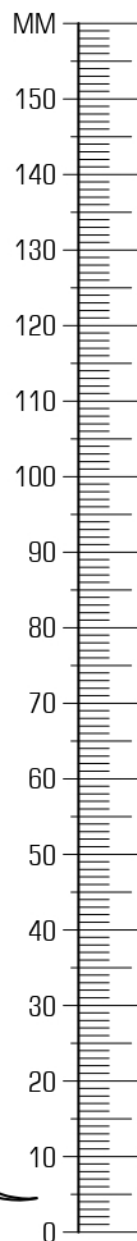
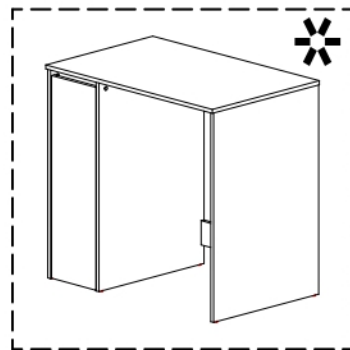
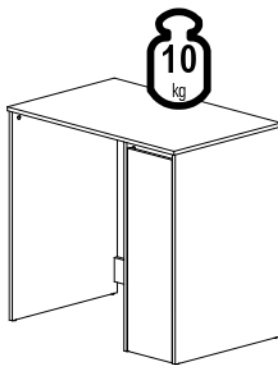

ID	ID	Icon	Icon	Icon
20964	②	935*600*16	1x	1/1
20963	③	864*590*16	1x	1/1
20965	④	864*590*16	1x	1/1
20966	⑤	864*590*16	1x	1/1
20967	⑥	627*100*16	1x	1/1
20968	⑦	256*100*16	1x	1/1
20969	⑧	836*250*16	2x	1/1
20970	⑨	538*230*16	3x	1/1
20971	⑩	538*70*16	6x	1/1

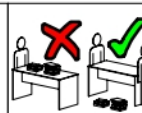
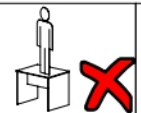
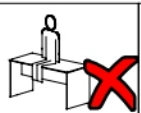
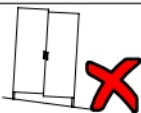

	A	21x		B	6x		C	6x		D	41x		E	41x		F	6x
	G	4x		H	1x		J	10x		K	1x		L	1x			

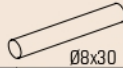

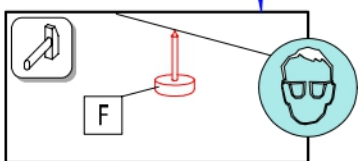
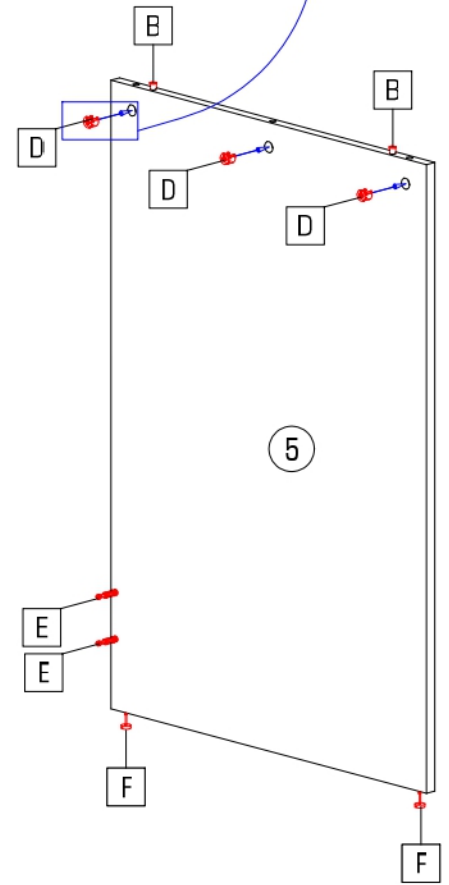
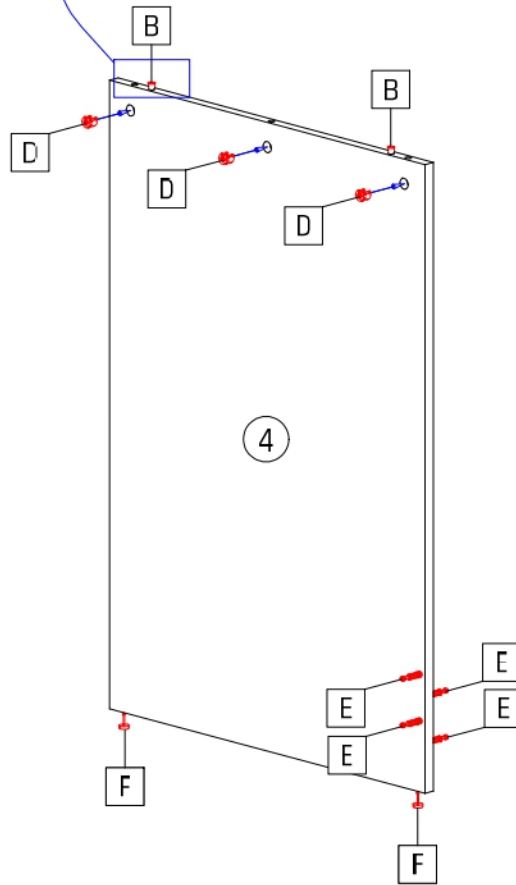
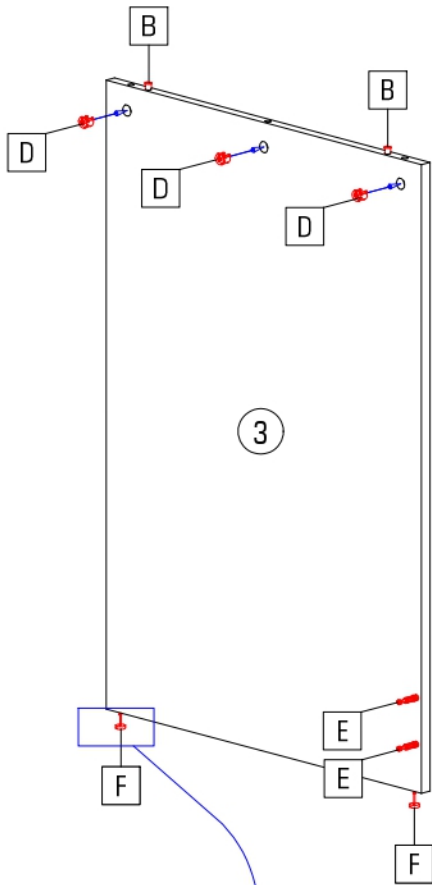
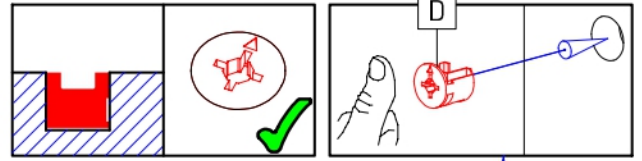
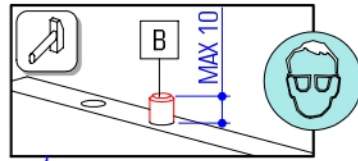
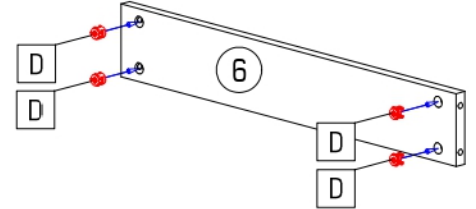
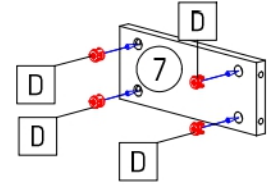
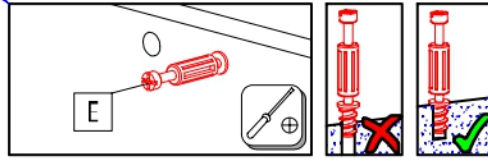
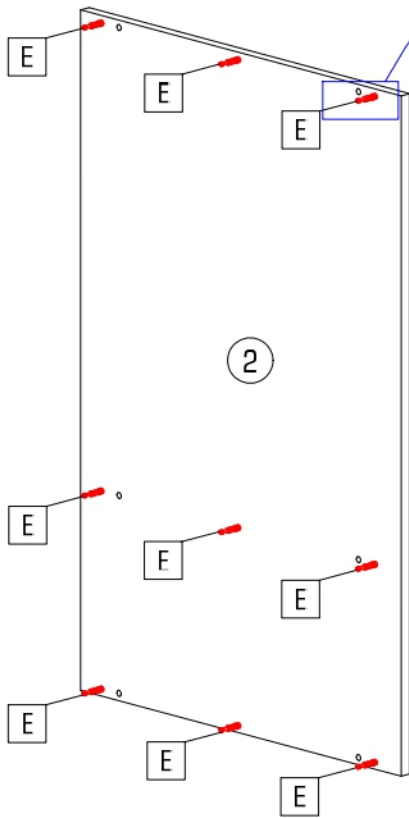

2/6 VLASTI

			
B 6x	D 17x	E 17x	F 6x

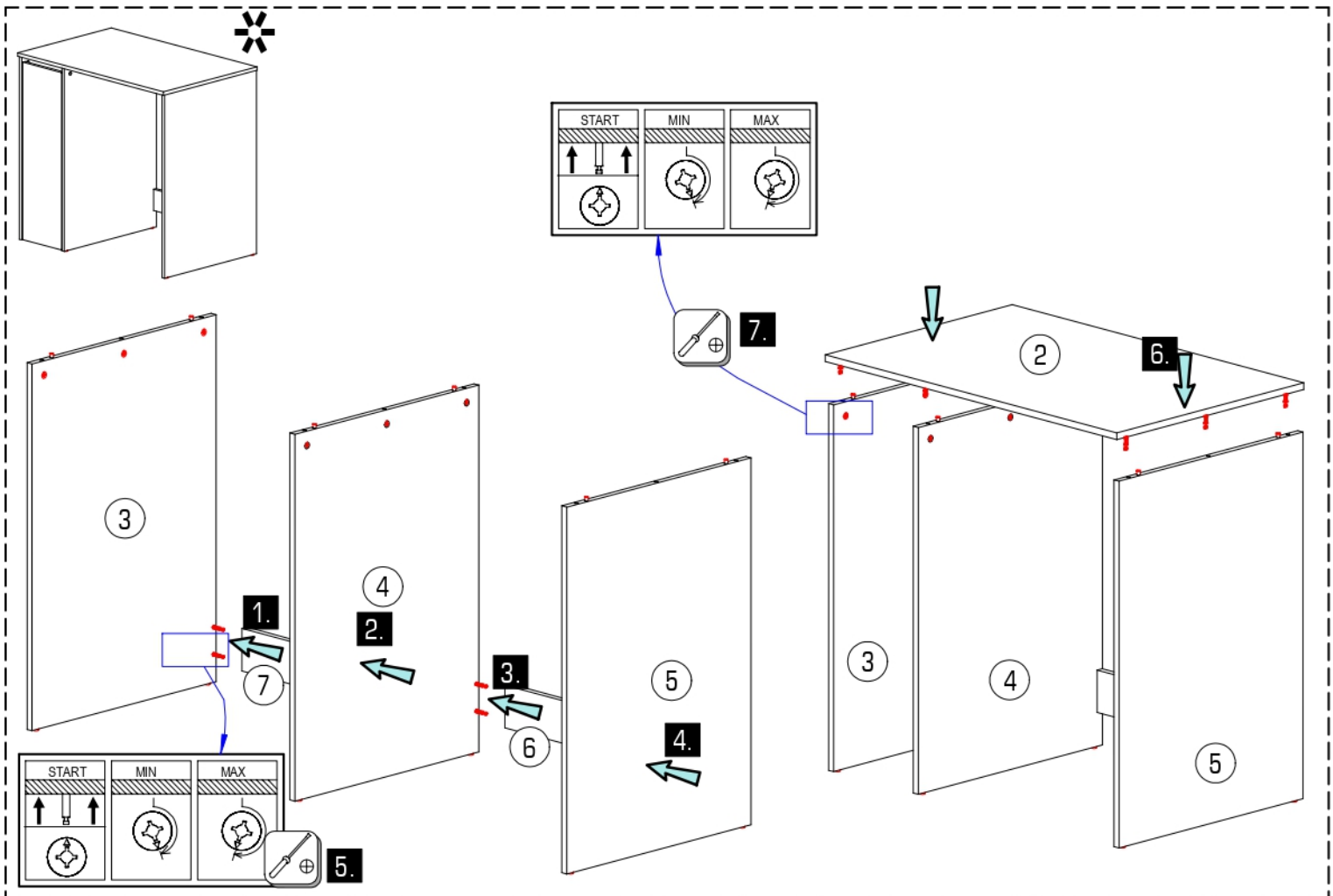
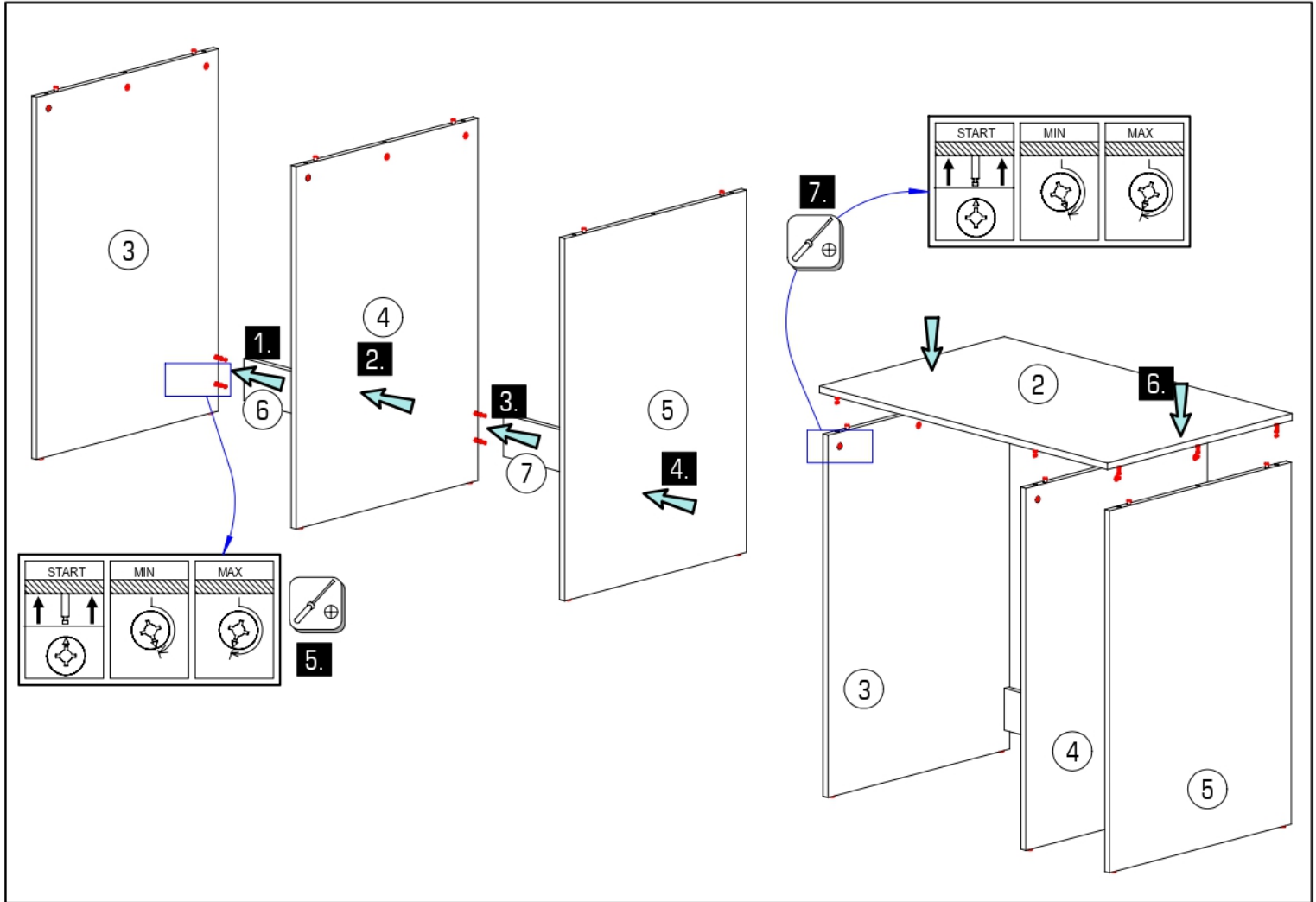







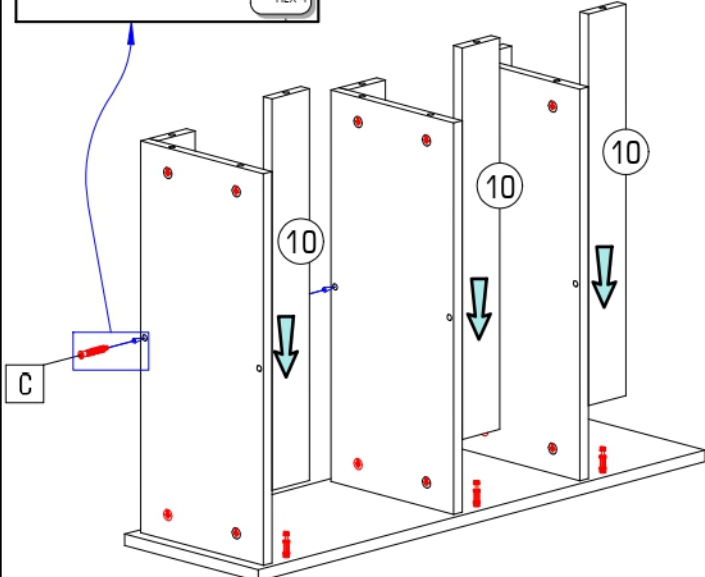
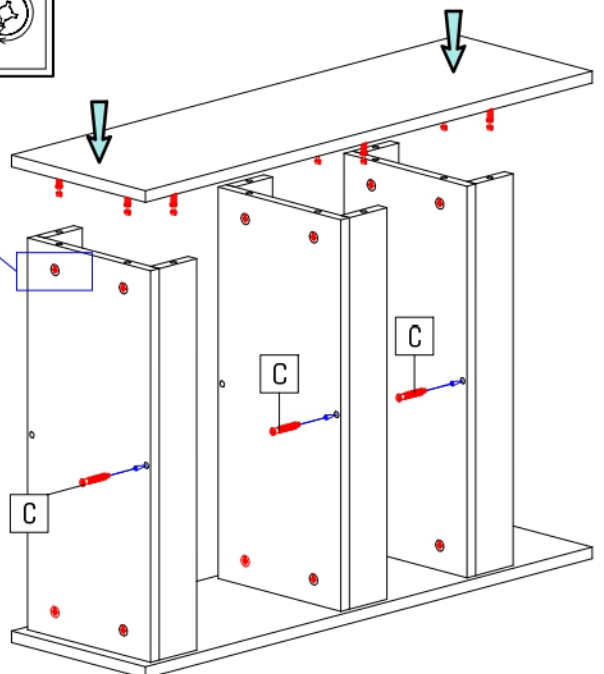
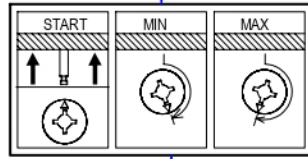
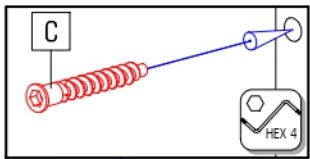
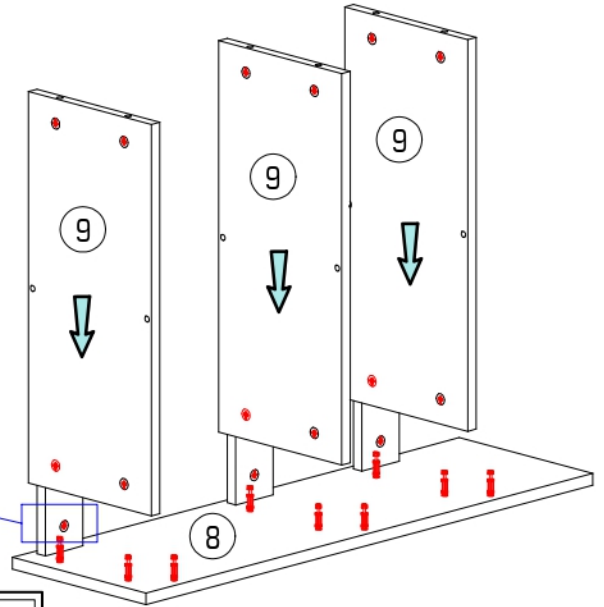
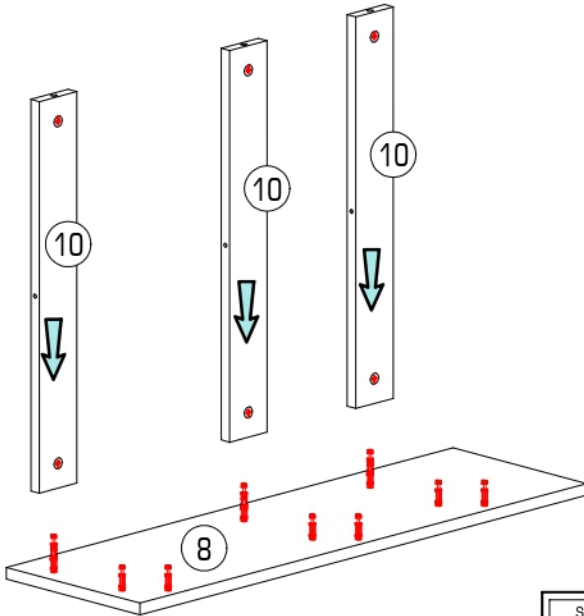
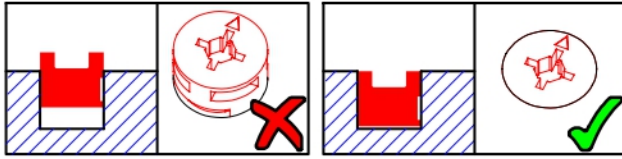
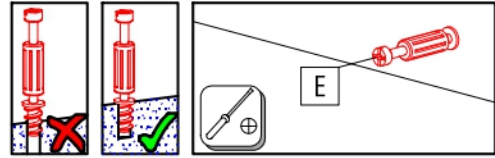
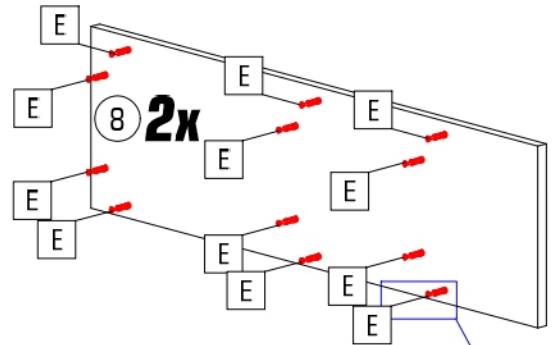
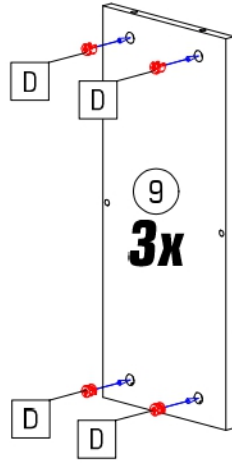
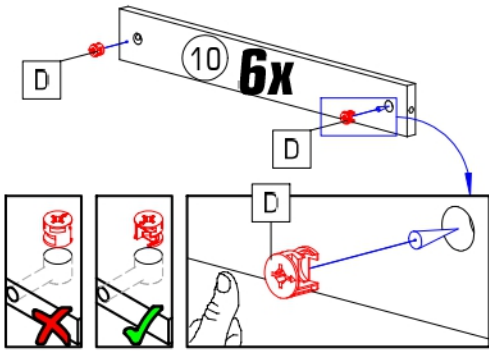

4/6 VLASTI

		
C	D	E
6x	41x	41x

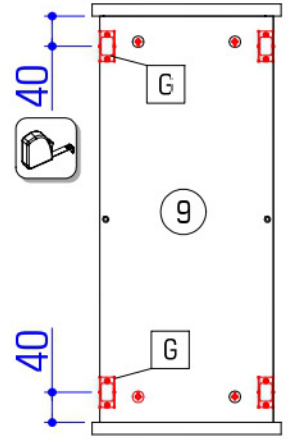
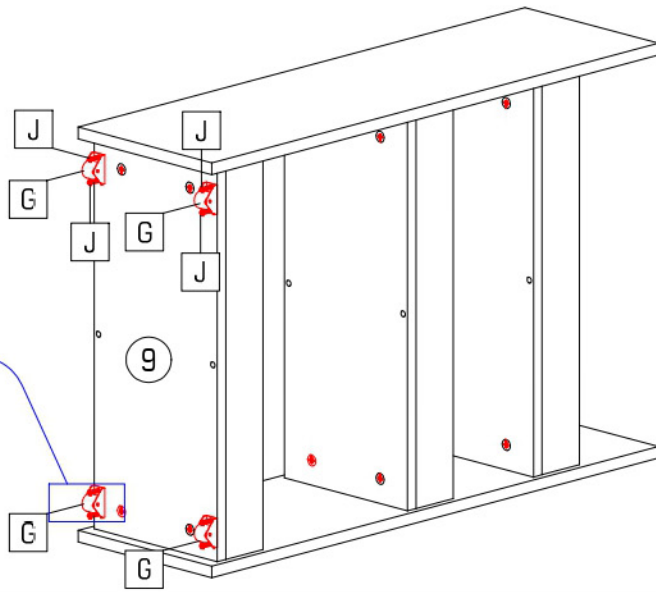
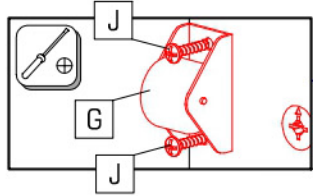

	Ø24		Ø3,5x16
G	4x	J	8x



	1x		Ø3,5x16		Ø5,0x70		Ø10
H	1x	J	2x	K	1x	L	1x

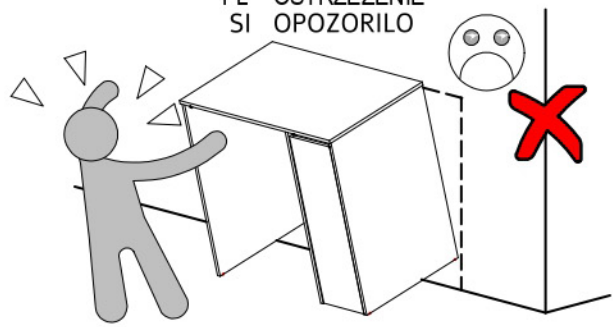
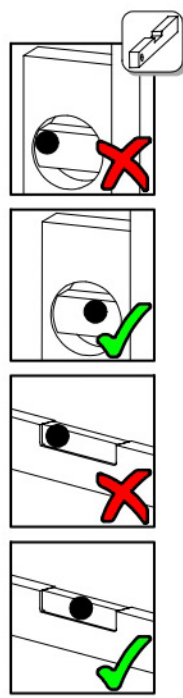
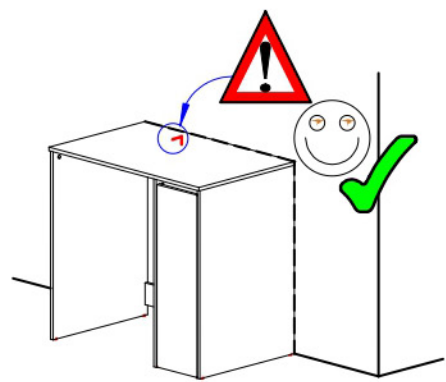
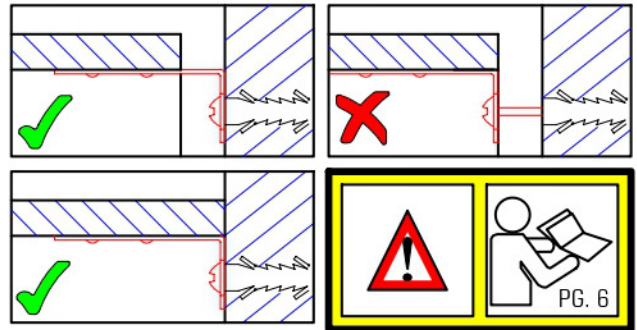
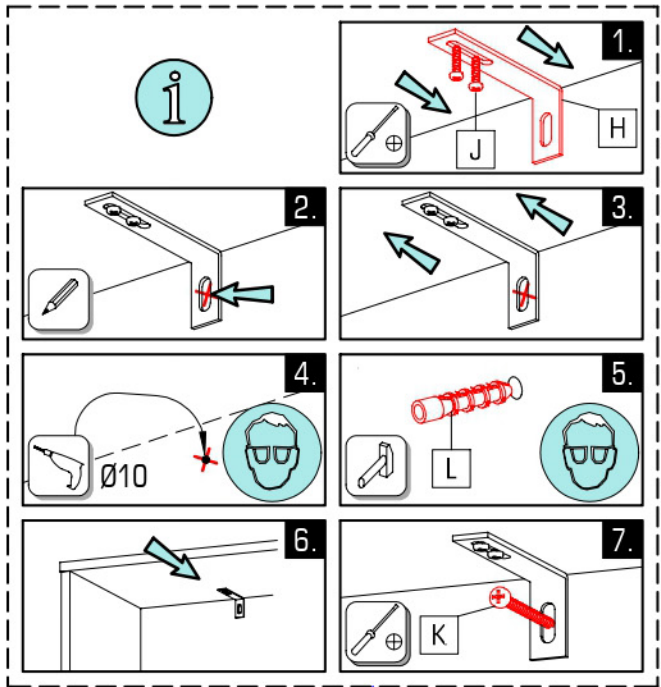

EN WARNING
 SK VÝSTRAHA
 CZ VAROVÁNÍ
 HR UPOZORENIE
 DE WARNUNG
 HU FIGYELEM
 RO AVERTIZARE
 UA УВАГА
 PL OSTRZEŻENIE
 SI OPOZORILO

6/6 VLASTI

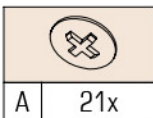

A 21x

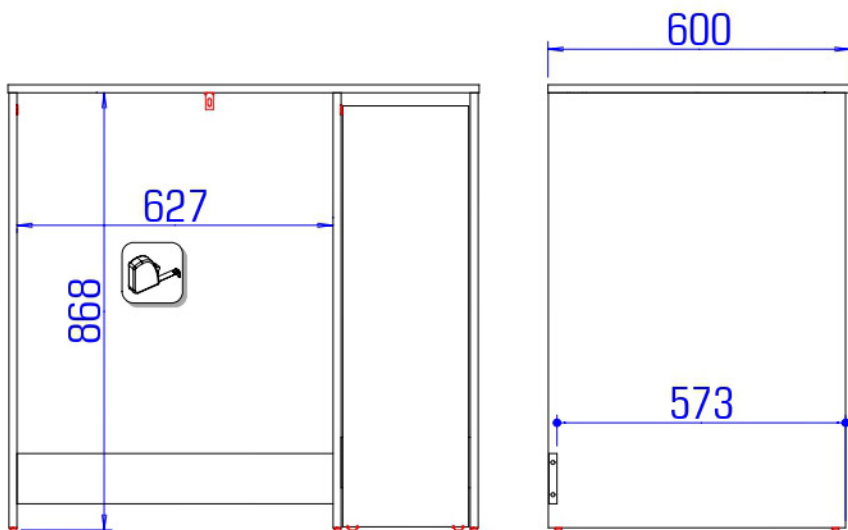
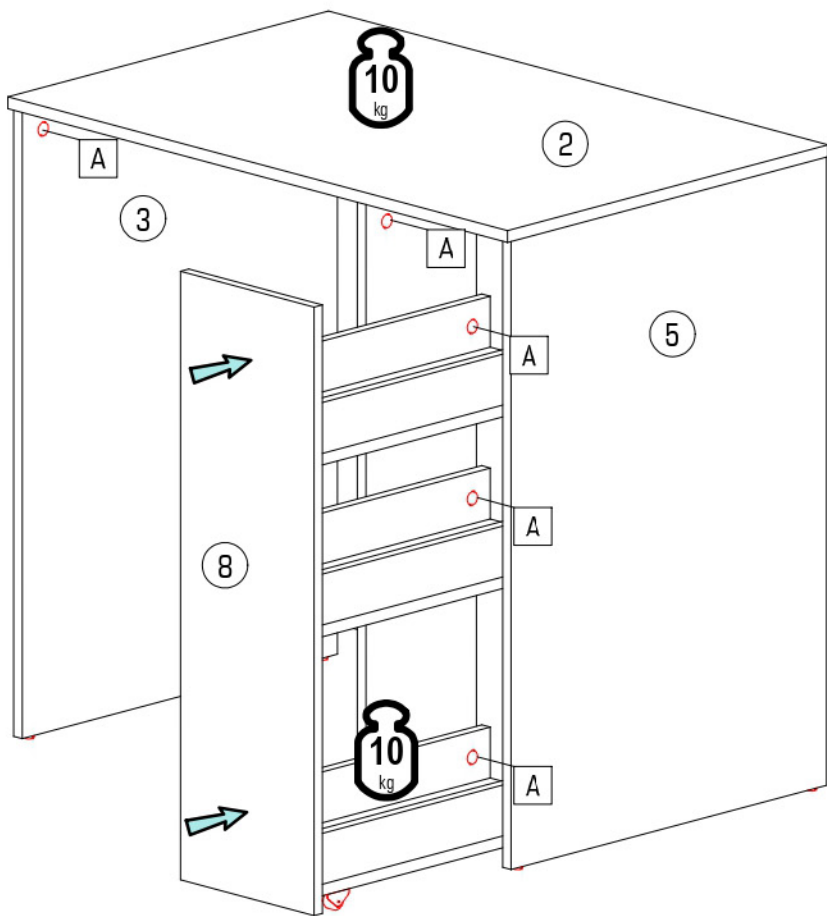
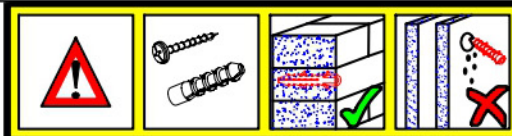

Upozornenie! Pevnosť steny sa musí pred montážou bezpodmienečne skontrolovať. Priložené univerzálne hmoždenky používajte jedine pre pevné murovo ako je betón/tehla. Hmoždenky sa nesmú používať v prípade ľahkého stavebného muriva, dutá tehla, Sádrokartónová doska, alebo iných konštrukcií rámu. U týchto stien je nutné použiť špeciálne hmoždenky! Tieto je možné dostať v špeciálnych predajniach so stavebným materiálom. Pri nedodržaní pokynov nepreberajú výrobcovia/predajci a dodávateľa zodpovednosť za vzniknuté škody.

Achtung! Die Wandbeschaffenheit ist vor der Montage unbedingt zu prüfen. Die beigelegten Universaldübel sind ausschließlich nur zur Verwendung für festes Mauerwerk wie Beton/Ziegel. Die Mauerdübel dürfen nicht bei Mauerwerk wie Hohlraumziegel, Leichtbausteinen, Gipskartonplatte oder anderer Rahmenbauweise verwendet werden. Bei diesen Mauerwerken sind gegebenenfalls Spezialdübel zu verwenden! Diese sind in einem Fachgeschäft erhältlich. Bei Nichteinhaltung wird seitens Produzenten/Händler und Importeur keine Haftung übernommen.

Uwaga! Ścianę należy sprawdzić przed montażem. Dołączone uniwersalne kołki rozporowe są odpowiednie tylko do stosowania w mocnych murach, takich jak beton lub cegła. Nie rób z pomocą kołków rozporowych mурowanych, takich jak pustak, lekka kostka, powierzchnie takie jak płyty gipsowo-kartonowe lub inne systemy ram. Jeśli dotyczy, muszą to być określone kołki rozporowe być użytym! Są one dostępne w specjalistycznym sklepie niezdolność, producent / sprzedawca lub importer nie ponoszą odpowiedzialności.

Upozornění! Před montáží je nutné zkontrolovat stav stěny. Příkladně univerzální hmoždinky jsou určeny pouze k použití pro pevné zdivo jako beton/cihly. Hmoždinky do zdi se nesmí používat u dutinová cihla, zdiva jako pórovitý stavební kámen, sádrokartónová deska nebo jiný měkký materiál. U těchto zdív jsou nutné použít speciální hmoždinky! Jsou k dostání v speciálních prodejnách se stavebním materiálem. Při nedodržení těchto pokynů výrobce/prodeje a dovozce neručí za způsobené škody.

Vigyázat! Szerelés előtt a falfelületet feltétlenül vizsgálja meg. A mellékelt univerzális tiplék kizárólag stabil falazathoz használható mint például beton/tégla. A fal tiplék nem használható könnyű építőkövekhez, üreg tégla, gipszkarton lapokhoz vagy más fázvas építményekhez. Ezekhez a falfelületekhez csak speciális tiplék használhatóak, melyek szaküzletekben (barkácsáruházakban) beszerezhetőek. Fentiek figyelmen kívül hagyása esetén a gyártó/kereskedő vagy forgalmazó nem vállal felelősséget.

Prudent! Zidul trebuie examinat înainte de asamblare prizele de perete sunt adecvate numai pentru utilizarea în zidărie fermă, cum ar fi betonul bloc sau cărămidă. Nu folosiți zidăria zidurilor de perete, cum ar fi caramida goală, blocul ușor, suprafețe cum ar fi gips-carton sau altă încadrare sisteme. Dacă este cazul, trebuie folosite anumite prize de perete! Acestea sunt disponibile la un magazin specializat (magazin de hardware). În caz de nerespectare, producătorul / vânzătorul cu amănuntul sau importatorul nu își asumă răspunderea.

Pažnja! Prije montaže obvezno provjerite svojstvo zida. Priložene univerzalne tiplje namijenjene su isključivo za masivne zidove od betona/opeke. Tiplje za masivne zidove ne smiju se koristiti za zidove kao npr šupljina opeka laki sastavni elementi, gips-kartonske ploče ili drugi modularni načini gradnje. Za te zidove potrebne su eventualno specijalne tiplje! Iste su dostupne u specijaliziranim trgovinama građevinskim materijalom. U slučaju nepridržavanja prethodno navedenih napomena, proizvođač/trgovac i uvoznik ne preuzimaju odgovornost!

Caution! The wall must be examined before assembly. The included universal wall plugs are only suitable for using in firm masonry such as concrete block or brick. Do not use the wall plugs masonry such as hollow brick, lightweight block, surfaces such as gypsum plasterboard or other framing systems. If applicable, particular wall plugs must be used! These are available at a specialised store (hardware store). In case of non-compliance, the manufacturer/retailer or importer do not assume liability.

Увага! Стан стіни необхідно перевірити перед установкою. Укладені універсальні дюбелі призначені лише для використання з фіксованими Кладка, як бетон / цегла. Антери для стін не повинні використовуватися для кладки Порожни цегли, легкі будівельні блоки, гіпсокартон або інша каркасна конструкція бути використаним. З цією кладкою можуть застосовуватися спеціальні дюбелі використання! Вони доступні в спеціалізованому магазині (магазині апаратних засобів) Виробник / дилер та імпортер не несе відповідальності.

Opozorilo! Pred vgradnjo je treba brezpogojno preveriti trdnost stene. Za trdne zidove, kot sta beton ali opeka, uporabljajte samo zatiče, ki so vključeni v paketu. Čepov ne smete uporabljati za lahke grajene zidake, votlo opeko, mavcnokartonske plošče ali druge okvirne konstrukcije. Za težjane konstrukcije je treba uporabiti posebne čepi! Te je mogoče dobiti v trgovinah z gradbenim materialom. V primeru neupoštevanja navodil proizvajalci/prodajalci in izvajalci ne prevzemajo odgovornosti za morebitno povzročeno škodo.

